

Omega profile – Type 1

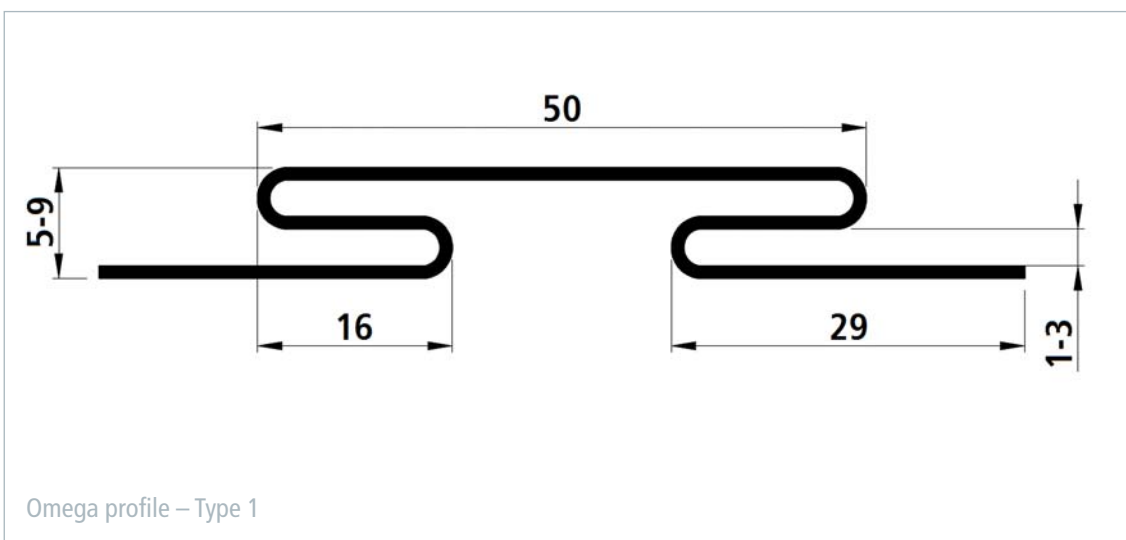

Omega profile – Type 1			
Technical data	Steel	Stainless steel	Aluminum
Fire classification	C	C	C
Thickness	0.7 – 1.0 mm	0.8 mm	1.0 – 1.2 mm
Element height	max. 2500 mm	max. 2500 mm	max. 2500 mm
Mass per area (L = 2500 mm)	2.0 – 2.9 kg/m ²	2.3 kg/m ²	1.0 – 1.2 kg/m ²
Coating	PVC foil varnish coated (other on request)	PVC foil varnish coated (other on request)	PVC foil varnish coated (other on request)

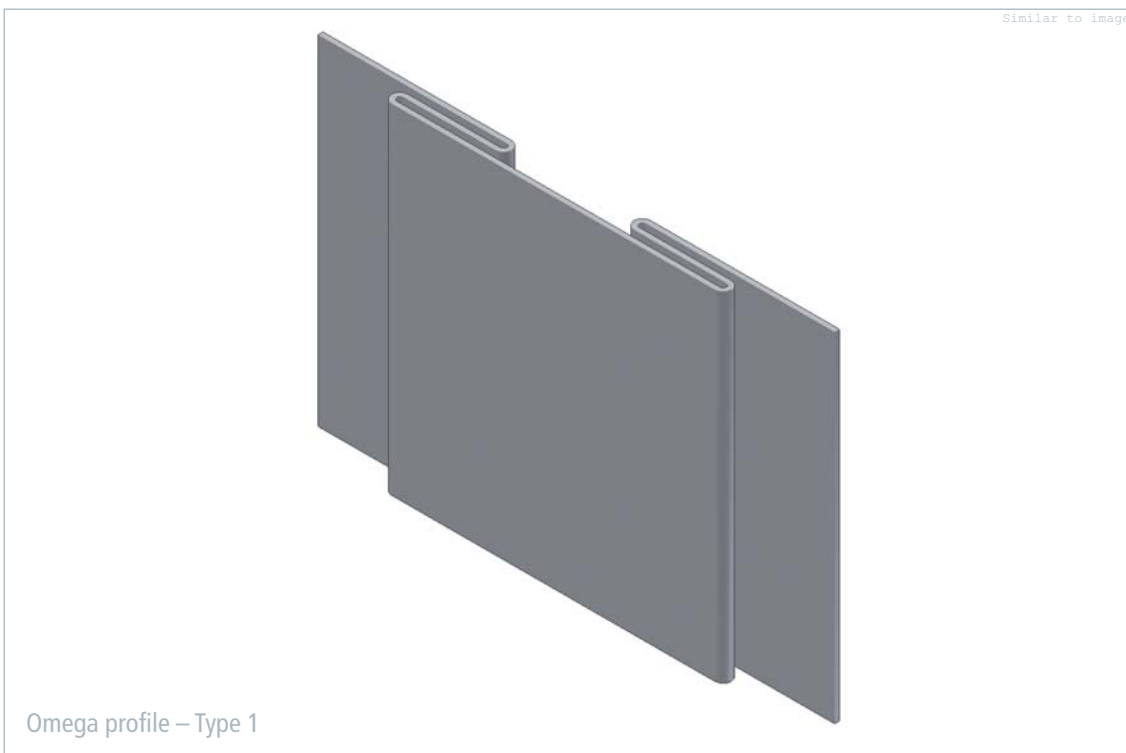

Others

